



# S2AF THRU S2MF

## SURFACE MOUNT GENERAL RECTIFIER

Reverse Voltage - 50 to 1000 Volts Forward Current - 2.0 Amperes

### SMAF

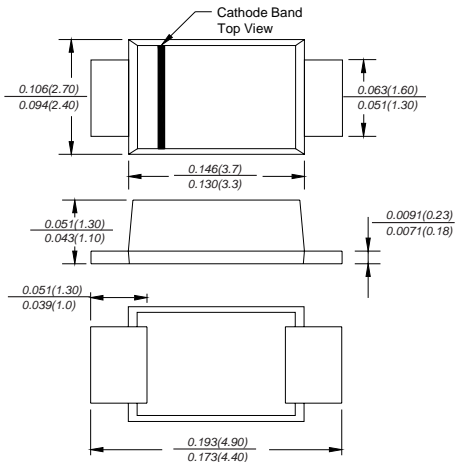

Dimensions in inches and (millimeters)

### FEATURES

- ◆ The plastic package carries Underwriters Laboratory Flammability Classification 94V-0
- ◆ For surface mounted applications
- ◆ Low reverse leakage
- ◆ Built-in strain relief, ideal for automated placement
- ◆ High forward surge current capability
- ◆ High temperature soldering guaranteed: 260°C/10 seconds at terminals
- ◆ Glass passivated chip junction

### MECHANICAL DATA

**Case:** JEDEC SMAF molded plastic body over passivated chip  
**Terminals:** Solder plated, solderable per MIL-STD-750, Method 2026

**Polarity:** Color band denotes cathode end

**Mounting Position:** Any

**Weight:** 0.0018 ounce, 0.064 grams

### MAXIMUM RATINGS AND ELECTRICAL CHARACTERISTICS

Ratings at 25°C ambient temperature unless otherwise specified.  
 Single phase half-wave 60Hz, resistive or inductive load, for capacitive load current derate by 20%.

MDD Catalog Number	SYMBOLS	S2AF	S2BF	S2DF	S2GF	S2JF	S2KF	S2MF	UNITS
Maximum repetitive peak reverse voltage	$V_{RRM}$	50	100	200	400	600	800	1000	VOLTS
Maximum RMS voltage	$V_{RMS}$	35	70	140	280	420	560	700	VOLTS
Maximum DC blocking voltage	$V_{DC}$	50	100	200	400	600	800	1000	VOLTS
Maximum average forward rectified current at $T_L=75^\circ\text{C}$	$I_{(AV)}$	2.0							Amps
Peak forward surge current 8.3ms single half sine-wave superimposed on rated load (JEDEC Method)	$I_{FSM}$	60.0							Amps
Maximum instantaneous forward voltage at 2.0A	$V_F$	1.1							Volts
Maximum DC reverse current at rated DC blocking voltage $T_A=25^\circ\text{C}$ $T_A=100^\circ\text{C}$	$I_R$	5.0 50.0							$\mu\text{A}$
Typical junction capacitance (NOTE 1)	$C_J$	30.0							pF
Typical thermal resistance (NOTE 2)	$R_{\theta JA}$	50.0							$^\circ\text{C}/\text{W}$
Operating junction and storage temperature range	$T_J, T_{STG}$	-50 to +150							$^\circ\text{C}$

**Note:** 1. Measured at 1MHz and applied reverse voltage of 4.0V D.C.  
 2. P.C.B. mounted with 0.2x0.2" (5.0x5.0mm) copper pad areas



# RATINGS AND CHARACTERISTIC CURVES S2AF THRU S2MF

AVERAGE FORWARD RECTIFIED CURRENT, AMPERES

FIG. 1- FORWARD CURRENT DERATING CURVE

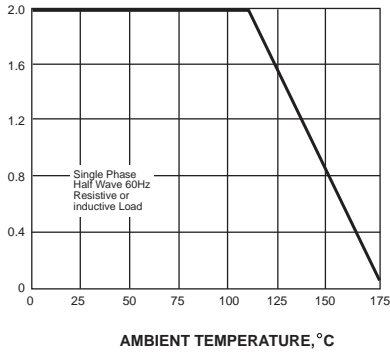

PEAK FORWARD SURGE CURRENT, AMPERES

FIG. 2-MAXIMUM NON-REPETITIVE PEAK FORWARD SURGE CURRENT

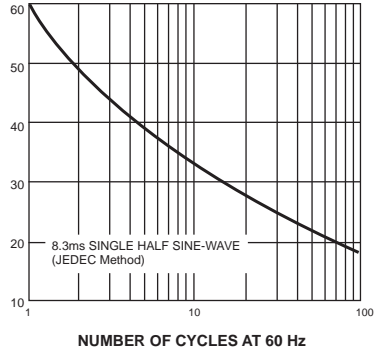

INSTANTANEOUS FORWARD CURRENT, AMPERES

FIG. 3-TYPICAL INSTANTANEOUS FORWARD CHARACTERISTICS

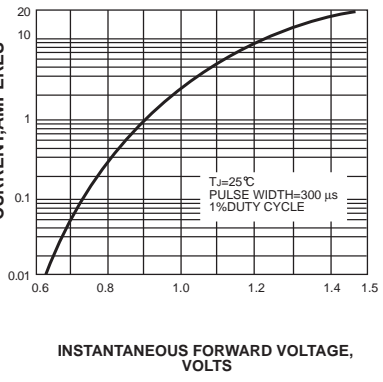

INSTANTANEOUS REVERSE CURRENT, MICROAMPERES

FIG. 4-TYPICAL REVERSE CHARACTERISTICS

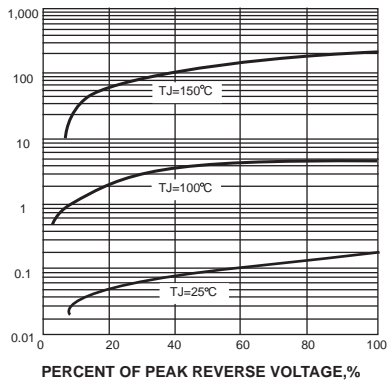

JUNCTION CAPACITANCE, pF

FIG. 5-TYPICAL JUNCTION CAPACITANCE

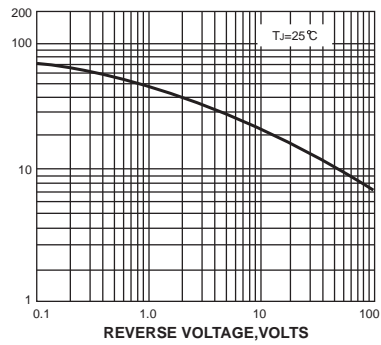

TRANSIENT THERMAL IMPEDANCE, °C/W

FIG. 6-TYPICAL TRANSIENT THERMAL IMPEDANCE

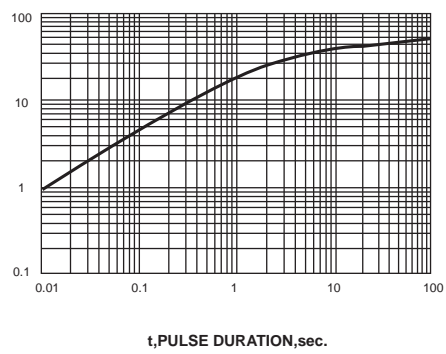

The cruve graph is for reference only, can't be the basis for judgment(曲线图仅供参考)!

